



Compacto
Express
protección solar

protección solar

compacto aluminio laminado
catálogo

www.compactoexpress.com

dimensiones disponibles (mm)

| | | | |
|----------|-----------|-----------|-----------|
| 137 x137 | 165 x 165 | 180 x 180 | 205 x 205 |
|----------|-----------|-----------|-----------|



Tabla de enrollamientos

| modelo de lama | Modelo cajón | | | | | | | | | | | | | |
|----------------|--------------|------|------|-----------|------|------|-----------|------|------|------|-----------|------|------|------|
| | 137 x137 | | | 165 x 165 | | | 180 x 180 | | | | 205 x 205 | | | |
| | Ø Eje | | | | | | | | | | | | | |
| | Ø 42 | Ø 50 | Ø 60 | Ø 42 | Ø 50 | Ø 60 | Ø 42 | Ø 50 | Ø 60 | Ø 70 | Ø 42 | Ø 50 | Ø 60 | Ø 70 |
| C-45 | 1750 | 1650 | 1200 | 2300 | 2200 | 2100 | 2750 | 2650 | 2500 | 2400 | 3400 | 3300 | 3200 | 3100 |
| C-56 | × | × | 700 | × | × | 1400 | × | × | 1700 | 1600 | × | × | 2600 | 2500 |
| CE-40 | × | 1050 | 950 | × | 1850 | 1750 | × | 1900 | 1800 | 1700 | × | 2750 | 2650 | 2550 |
| ATB-45 | × | 1100 | 1000 | × | 1800 | 1700 | × | 2200 | 2100 | 2000 | × | 2750 | 2650 | 2550 |
| ATB-39 | × | 1350 | 1250 | × | 2300 | 2200 | × | 2850 | 2750 | 2650 | × | 3200 | 3100 | 3000 |
| CP-39 | 1650 | 1650 | 1200 | 2300 | 2200 | 2100 | 2750 | 2650 | 2500 | 2400 | 3400 | 3300 | 3200 | 3100 |

Modelos de lama compatibles

| Modelo | Laminado | | Aluminio extrusionado | | | Pvc |
|------------------------|---|---|---|--|---|---|
| | C-45 | C-56 | CE-40 | ATB-45 | ATB-39 | CP-39 |
| |  |  |  |  |  |  |
| Peso m ² | 3.5 Kg | 3.5 Kg | 10 Kg | 11 Kg | 11 Kg | 4.5 Kg |
| Ancho máximo | 2500 mm | 3500 mm | 3000 mm | 3000 mm | 2500 mm | 1400 mm |
| Alto máximo | 3000 mm | 4000 mm | 4000 mm | 3500 mm | 3500 mm | 2400 mm |
| Superficie máxima | 6 m ² | 8 m ² | 8 m ² | 8 m ² | 7 m ² | 3.5 m ² |
| Terminales compatibles | TER-GOM TER-FL68 | TER-GOM TER-FL68 | TER-GOM TER-FL68 | TER-ATB | TER-FL68 | ER-GOM / TER- FL68 |
| Ø Eje mínimo | Ø 42 mm | Ø 60 mm | Ø 60 mm | Ø60 mm | Ø 60 mm | Ø42 mm |

Resistencia al viento (medidas hueco luz)

| modelo | 120 x 200 | 150 x 200 | 210 x 250 | 2400 x 2500 | 2500 x 2500 | 2700 x 2500 | 3000 x 2500 | 3500 x 2500 |
|--------|-----------|-----------|-----------|-------------|-------------|-------------|-------------|-------------|
| C-45 | 6 | 5 | 3 | 2 | 1 | 1 | 0 | 0 |
| C-56 | 6 | 6 | 4 | 3 | 3 | 3 | 2 | 1 |
| CE-40 | 6 | 6 | 6 | 6 | 5 | 4 | 4 | 3 |
| ATB-45 | 6 | 6 | 6 | 6 | 5 | 5 | 5 | 3 |
| ATB-39 | 6 | 6 | 6 | 6 | 5 | 5 | 5 | 3 |
| CP-39 | 3 | 1 | 0 | 0 | 0 | 0 | 0 | 0 |

Equivalencias

| | | | | | | | |
|-----------|-------|-------|-------|-------|-------|------|-------|
| Km / hora | 110 | 90 | 70 | 55 | 45 | 35 | <35 |
| Mts / seg | 30.55 | 25.00 | 19.44 | 15.28 | 12.50 | 9.72 | <9.72 |
| Clase | 6 | 5 | 4 | 3 | 2 | 1 | 0 |

Cálculos realizados según norma EN 13659

Color y modelo disponibles



Blanco

C-45 / C-56 (pintura liquida)
CE-40 / ATB-45 / ATB-39 (pintura epoxi)
CP-39 (coloreado en masa)



Plata

C-45 / C-56 (pintura liquida)
CE-40 / ATB-45 / ATB-39 (anodizado)
CP-39 (coloreado en masa)



Bronce

C-45 / C-56 (pintura liquida)
CE-40 / ATB-45 / ATB-39 (anodizado)



Ral 1015 (marfil)

C-45 / C-56 (pintura liquida)
CE-40 / ATB-45 / ATB-39 (pintura epoxi)
CP-39 (coloreado en masa)



Ral 3005

C-45 / C-56 (pintura liquida)
CE-40 / ATB-45 / ATB-39 (pintura epoxi)



Ral 6005

C-45 / C-56 (pintura liquida)
CE-40 / ATB-45 / ATB-39 (pintura epoxi)



Ral 6009

C-45 / C-56 (pintura liquida)
CE-40 / ATB-45 / ATB-39 (pintura epoxi)



Ral 7011

C-45 / C-56 (pintura liquida)
CE-40 / ATB-45 / ATB-39 (pintura epoxi)



Ral 8014

C-45 / C-56 (pintura liquida)
CE-40 / ATB-45 / ATB-39 (pintura epoxi)



Ral 9075

C-45 / C-56 (pintura liquida)
CE-40 / ATB-45 / ATB-39 (pintura epoxi)



Negro 9020

C-45 / C-56 (pintura liquida)
CE-40 / ATB-45 / ATB-39 (pintura epoxi)



Madera claro

C-45 / C-56 (pintura liquida)
CE-40 / ATB-45 / ATB-39 (pintura epoxi)

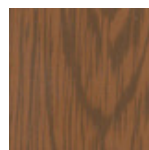

Madera oscuro

C-45 / C-56 (pintura liquida)
CE-40 / ATB-45 / ATB-39 (pintura epoxi)

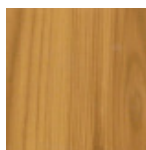

Nogal claro

C-45 / C-56 (pintura liquida)
CE-40 / ATB-45 / ATB-39 (pintura epoxi)

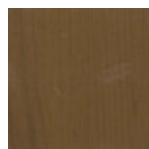

Nogal oscuro

C-45 / C-56 (pintura liquida)
CE-40 / ATB-45 / ATB-39 (pintura epoxi)

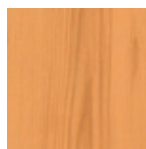

Pino nudos

C-45 / C-56 (pintura liquida)
CE-40 / ATB-45 / ATB-39 (pintura epoxi)

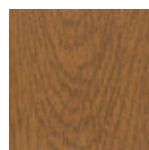

Roble golden

C-45 / C-56 (pintura liquida)
CE-40 / ATB-45 / ATB-39 (pintura epoxi)

Debido a los diferentes ajustes de pantalla o impresión la tonalidad de los colores puede variar, por lo tanto las muestras de color expuestas SOLAMENTE SE DEBEN TOMAR COMO ORIENTATIVAS.

□ Para cualquier otro acabado de color. Solicite disponibilidad y precio.

Acabados normalizados y medidas disponibles

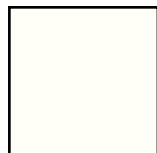

Blanco
137 / 165 / 180 / 205

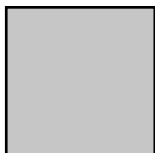

Plata
137 / 165 / 180



Bronce
137 / 165 / 180

Acabados RAL estándar y medidas disponibles

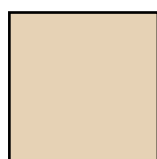

Ral 1015 (marfil)
137 / 165 / 180



Ral 3005
137 / 165 / 180



Ral 6005
137 / 165 / 180



Ral 6009
137 / 165 / 180



Ral 7011
137 / 165 / 180



Ral 8014
137 / 165 / 180



Ral 9075
137 / 165 / 180



Negro 9020
137 / 165 / 180

Acabados imitación madera y medidas disponibles

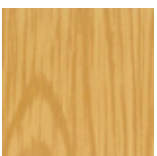

Madera claro
137 / 165 / 180

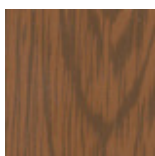

Madera oscuro
137 / 165 / 180

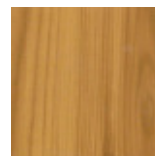

Nogal claro
137 / 165 / 180

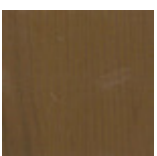

Nogal oscuro
137 / 165 / 180

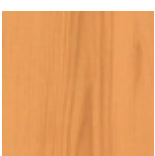

Pino nudos
137 / 165 / 180

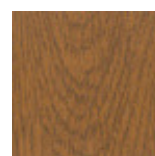

Roble golden
137 / 165 / 180

Debido a los diferentes ajustes de pantalla o impresión la tonalidad de los colores puede variar, por lo tanto las muestras de color expuestas SOLAMENTE SE DEBEN TOMAR COMO ORIENTATIVAS.

□ Para cualquier otro acabado de color o medida de cajón. Solicite disponibilidad y precio.

Cajones

CAJÓN 137

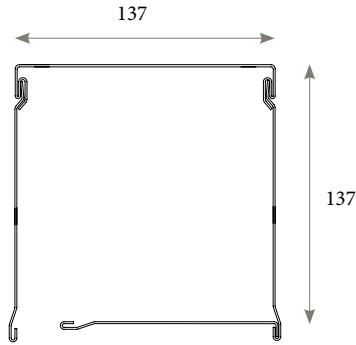

CAJÓN 165

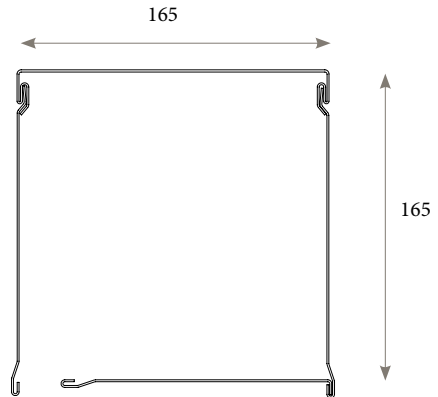

CAJÓN 180

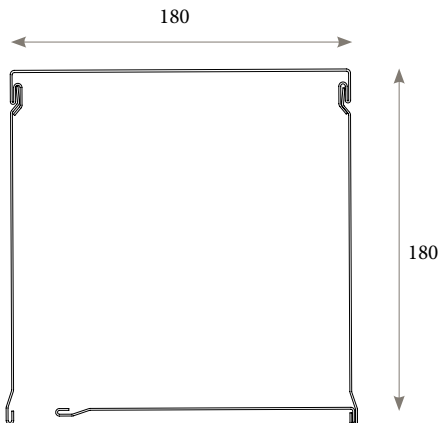

CAJÓN 205

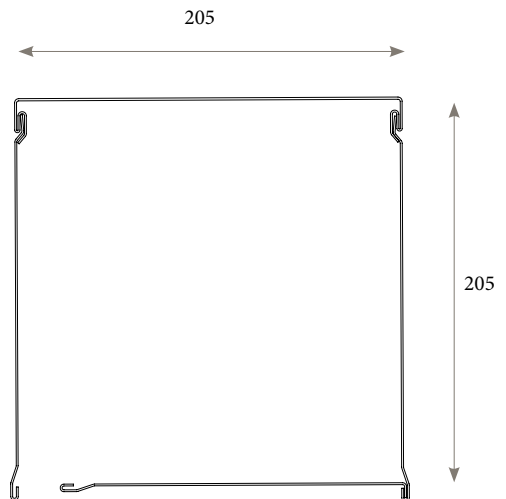

Terminales compatibles

TER-GOM

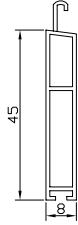

C-45 / C-56 / CP-39

TER-ATB45

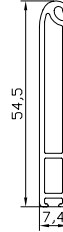

ATB- 45

TER-FL68



C-45 / C-56 / CP-39 / ATB-39

Complementos

ANG-CUV

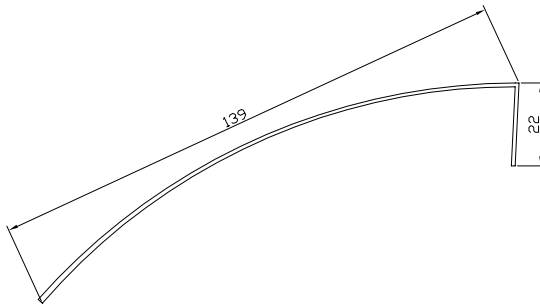

ANG -REG

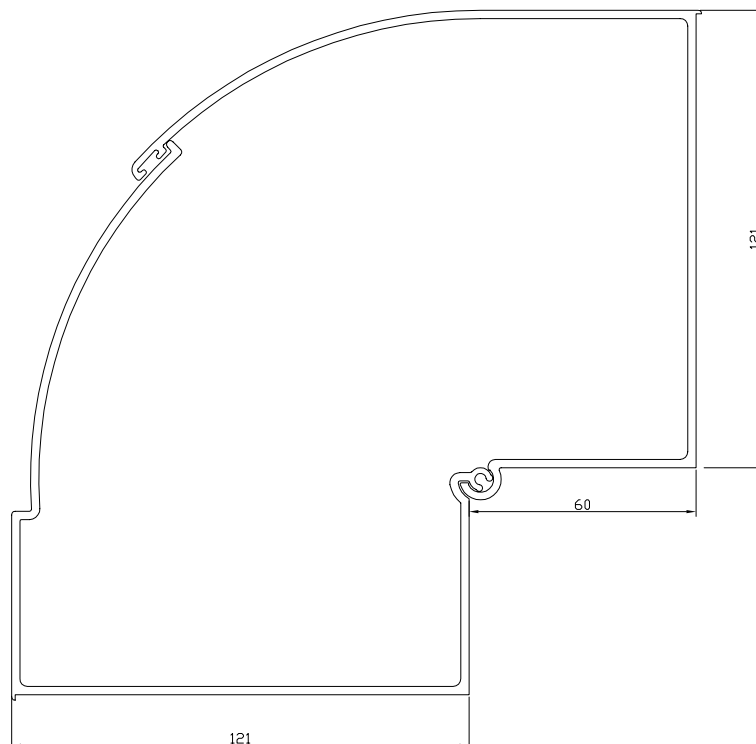



Guías para acoplar en carpintería

GUIA4

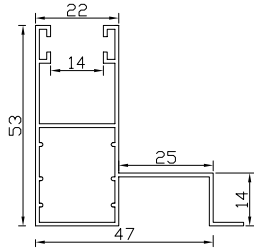

GUIE4

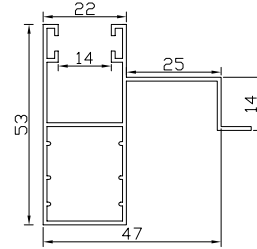

GUIA6

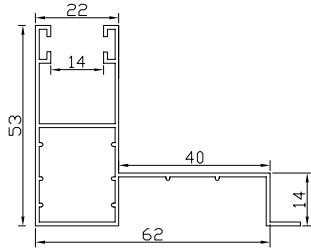

GUIE6

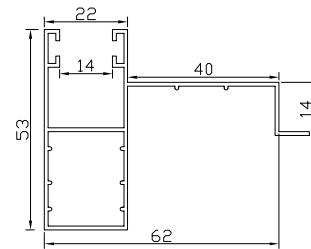

GUIA68

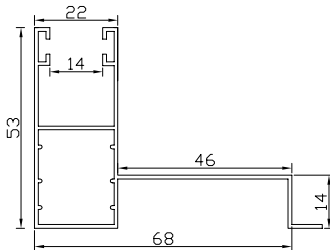

GUIE68

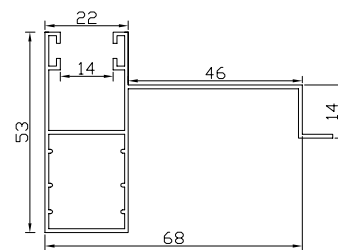

GUIA7

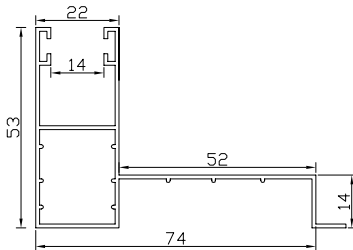

GUIE7

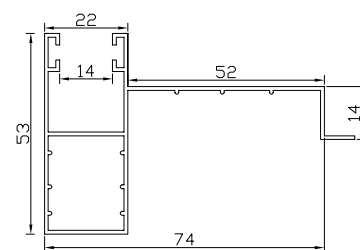

GUIA8

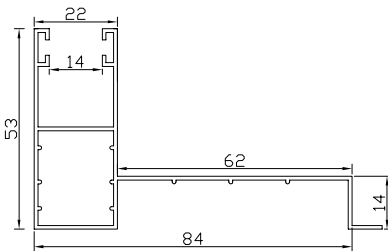

GUIE8

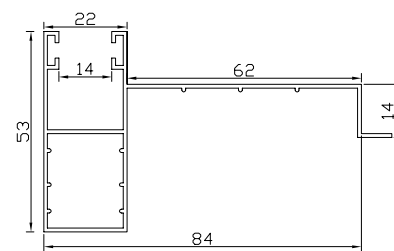

GUIA10

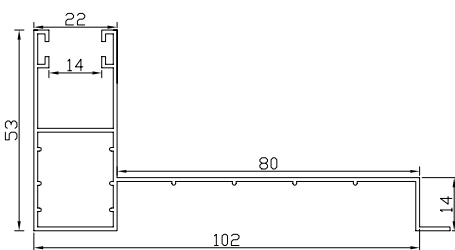

GUIE10

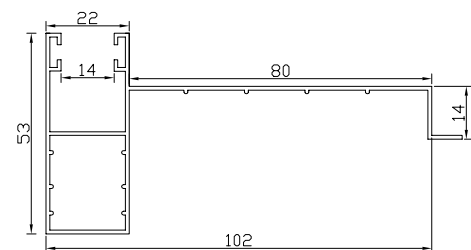

GUIA11

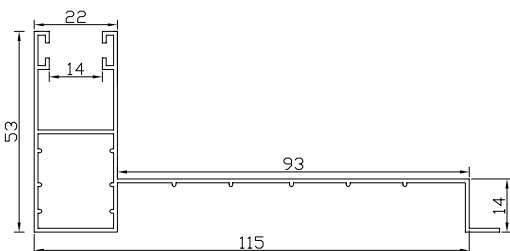

GUIE11

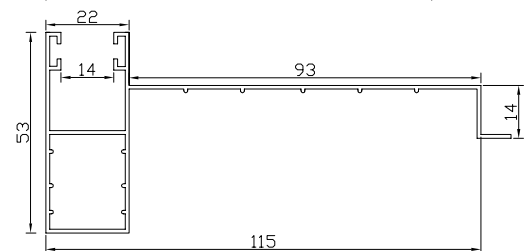



Guías para acoplar en carpintería

GUIH25

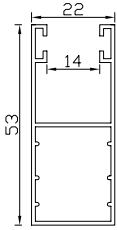

GUIHS

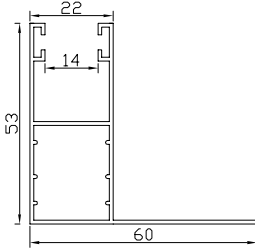

GUIHSL

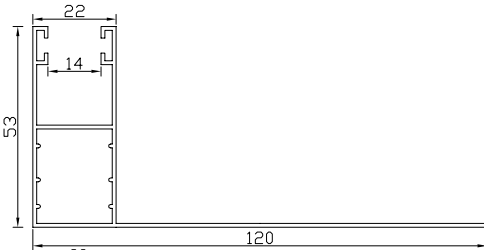

GUIM100

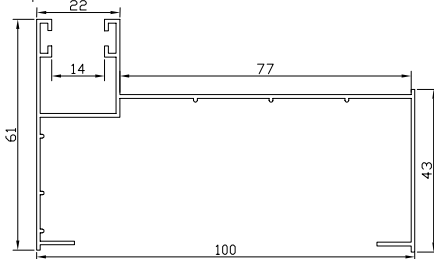

GUIM130

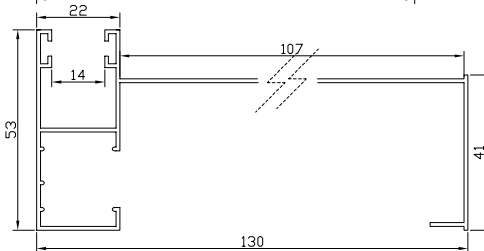

GUIM155

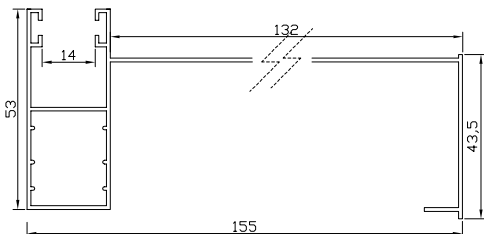

GUIM180

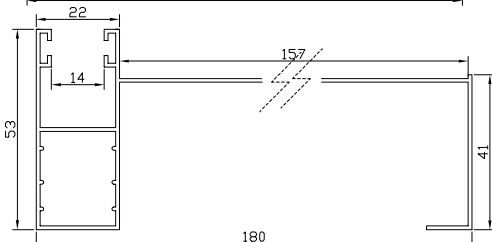

GUIHD

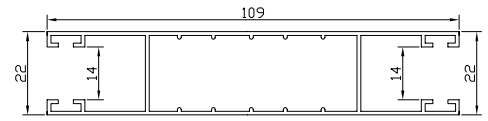

GUIHE

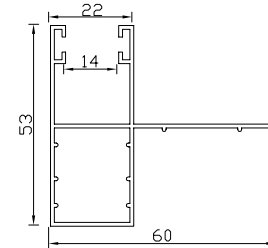

GUIHSE

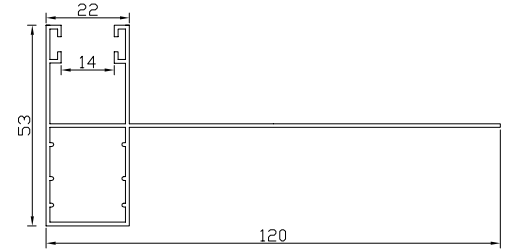

GUIM120

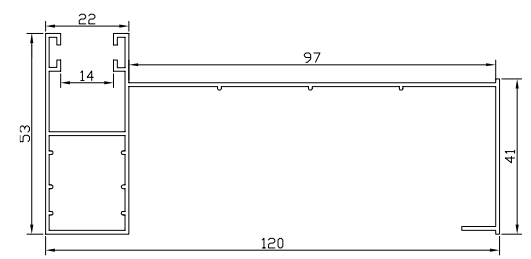

GUIM140

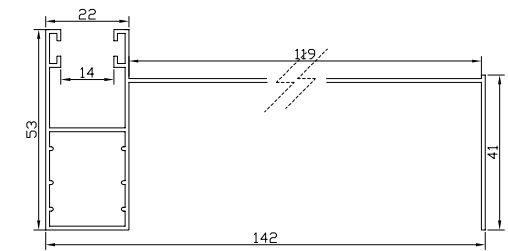

GUIM168

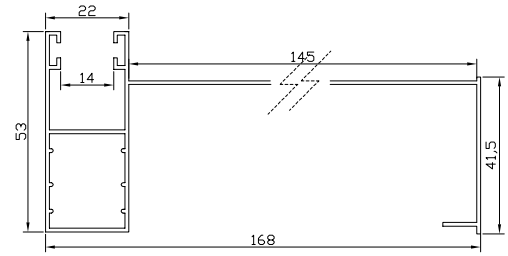

GUIM198

